

HIGHLY  
SECURE  
VANDAL RESISTANT

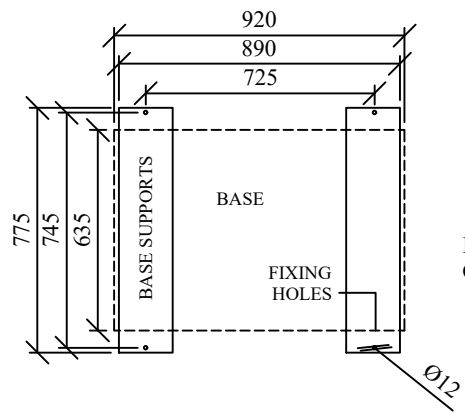

PLAN VIEW  
OF UNIT BASE

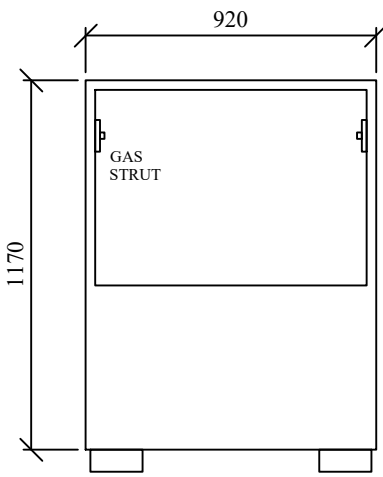

VIEW OF ACCESS  
OPENING - LID  
REMOVED

BASE SUPPORTS DOUBLE  
AS FORKLIFT POINTS

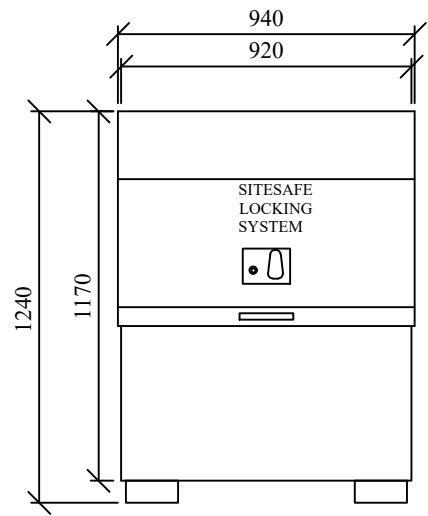

FRONT ELEVATION

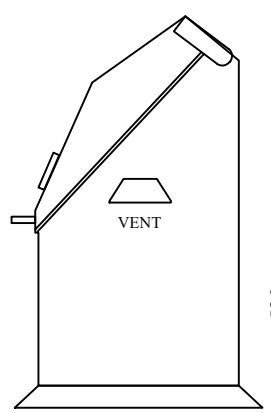

SIDE ELEVATION

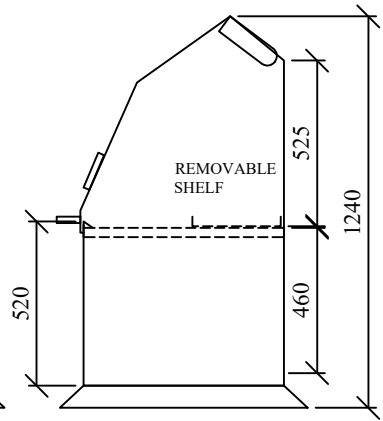

SIDE ON SECTION

DO NOT SCALE

REMOVE ALL  
BURRS AND  
SHARP EDGES



THIRD ANGLE  
PROJECTION

REV No	DATE	BY	CUSTOMER
REV 1			
REV 2			
REV 3			
REV 4			

CLEVELAND  
SITESAFE  
LIMITED

RIVERSIDE WORKS  
CLEVELAND  
TS3 8AT  
01642 244663

DRAWN JWH	DESCRIPTION
SCALE	UNIVERSAL 270 UNIT
DATE 26/06/2009	DRG No UNI270WEB